



Invisible innovation,
visible impact.



Company Profile



Water



Gas



Sewerage



Heating



Filtration



Mission

To innovate and produce sustainable systems for water, gas, sewerage, heating and filtration systems, essential for the infrastructure of any residential or industrial living space.

Vision

Until 2035, we aim to become the regional leader in solutions for water, gas, sewerage, heating and filtration infrastructure, using invisible technology with visible impact on safety, efficiency and daily comfort of every community.

Although invisible, our systems support the safety and efficiency of every space, delivering sustainable performance in everyday life.

30 years of experience

Invisible innovation, visible impact.





Valrom Group in numbers in 2025:

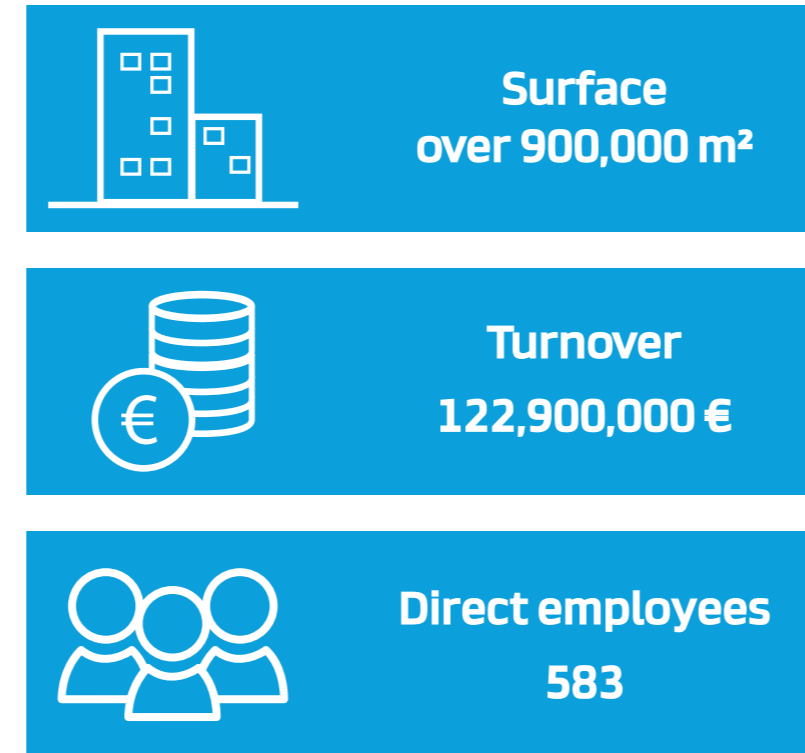

4 factories

VALROM GROUP

Founded in 1996, part of the **Silmar** and **Perini Group**, Valrom Industrie emerged from a strategic decision to provide complete solutions for Romania's infrastructure in water, gas, and sewerage networks.

Today, Valrom Group manufactures and markets pipes, fittings, and other plastic products (Polyethylene - PE, Polypropylene - PP and Polyvinyl Chloride - PVC), establishing a strong regional presence in South-East Europe.

As a distributor, Valrom Industrie maintains a loyal network of major customers across Romania, Ukraine, the Republic of Moldova, Bulgaria, and Greece.

Committed to social responsibility, environmental protection, and sustainable development, the company continuously invests in research and innovation.



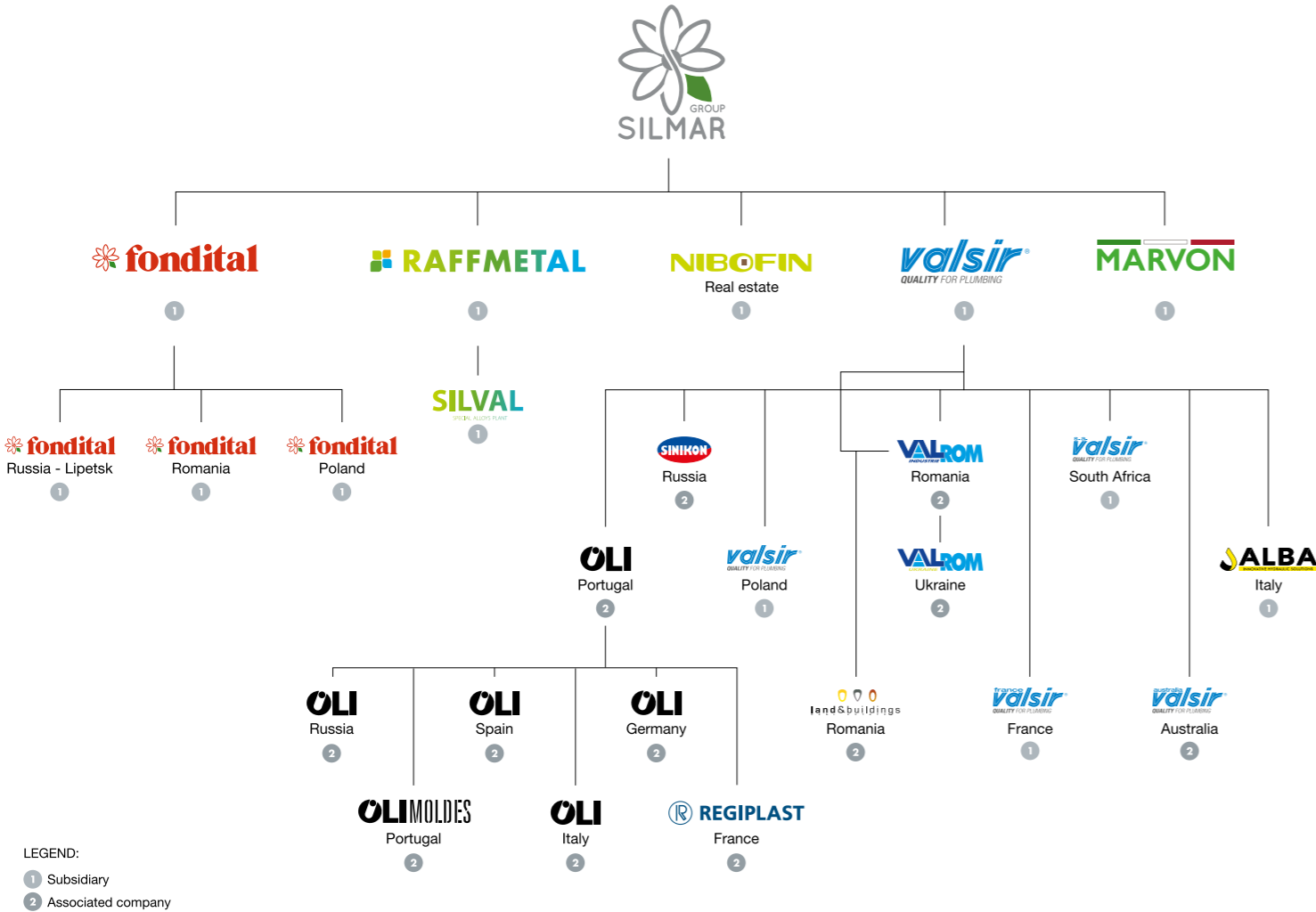

Silmar Group in numbers in 2024:

Surface
 2,078,625 m²
 of which
 632,476 m² indoors

Turnover
 1,435,510,000 €

Direct employees
 3,632

SILMAR GROUP

The Group was founded in 1970 thanks to the intuition and strategy of Silvestro Niboli, who focused on diversifying production and set extremely high quality standards, which were adopted by all the companies he founded.

Silmar Group was founded with the vision of a modern industrial group, ready to compete in international markets.

The companies in the Group, interconnected thanks to a clear overall vision, are now one of the main international players in Italian industry. Silmar Group looks to the future with steady growth, confirming the strong synergy between the different companies that are part of it.



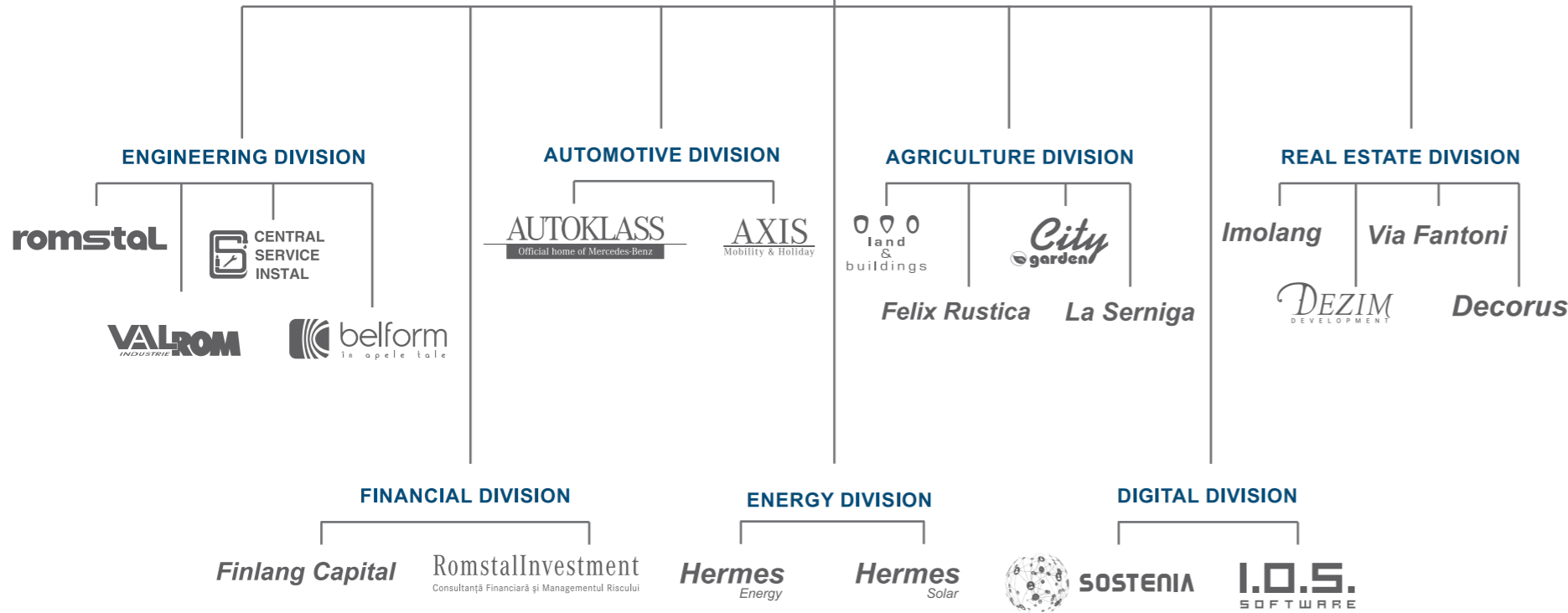

PERINI GROUP

Perini Group includes **20 companies** organized into **7 divisions**: Engineering, Automotive, Real Estate, Energy, Agriculture, Digital and Financial. At the heart of the organization lies a commitment to **excellence, innovation, and unwavering** dedication to the customers' needs.

As it forges ahead, Perini Group continues to drive innovation, create synergies among diverse activities, and deliver exceptional solutions and services.

Romstal is the most dynamic and important company on the Romanian market in terms of selling heating and plumbing equipment, with more than 150 stores and franchises across five countries in Eastern Europe.

Perini Group in numbers in 2025:

Turnover
898,000,000

Direct employees
3,700





181,000 sq.m outdoors storage areas
17,000 sq.m covered storage area
35,000 sq.m production area

3 factories:

» **Bucharest – Headquarters**

- Extruding of PE, PP, PP-R, PEX
- Injection Moulding PP, PP-R, PVC, PPSU
- Welding

» **Bucharest – PVC factory (VALPlast)**

- Extruding of PVC

» **Pantelimon – Rotomoulding**

- Rotomoulding of PE

Turnover 2025: 113,700,000 euro

Employees: 522

Valrom Romania

233,000 sq.m surface

13,500 products supplied

6,000 products manufactured

Invisible innovation, visible impact.



Water



Gas



Sewerage



Heating



Filtration

It's simple to enjoy complete systems



Equipment: **26 extruding lines**
(5 quick switch lines)
Raw material:
PE, PP, PVC, PPR, PEX, PE-RT
Annual production capacity:
30,000 T/year

Products - pipes for:

- Water supply systems
- Irrigation systems
- Gas supply systems
- Internal and external sewage
- Sanitary and heating systems

Size range: **D14 - D1200 mm**

Extruding

26 extruding
lines

2,100 extruded
products

Invisible innovation, visible impact.



Water



Gas



Sewerage



Heating



Filtration



Equipment: **36 injection moulding machines**
 Raw materials: **PP, PVC, PE**
 Annual production capacity: **1,800 T/year**

- Products:
- PP internal sewage fittings
 - PVC sewage fittings
 - Water/Gas fittings and electro-fittings
 - PP-R fittings
 - PPSU fittings

Injection moulding

36 injection moulding

650 injected products

It's easy when you're the partner of the leader



Equipment: **9 extruding lines, 2 hydraulic press machines**
Raw material: **PVC, SMC**
Annual production capacity: **20,000 T/year**

26,800 sq.m outdoors storage area
8,200 sq.m covered storage area

Products:

- PVC Pipes and connections for drains
- Water well pipes and filters
- PVC Pressure pipes
- Pipes for protection of electrical and telecommunication cables
- Inspection chambers
- Composite manhole covers

Size range: **D 20 - D 630 mm**

PVC Factory

35,000 sq.m surface

1,000 extruded products

Invisible innovation, visible impact.



It's simple to enjoy complete systems



Equipment: **3 rotomoulding machines**
Raw material: **PE**
Annual production capacity:
2,200 T/year

8,500 sq.m outdoors storage area
2,500 sq.m covered storage area

Products:

- Water Tanks
- Inspection and visit chambers
- Water meters chambers
- Well chambers
- Wastewater treatment plants



Rotomoulding

11,000 sq.m
surface

600 rotomoulding
products

Invisible innovation, visible impact.





Equipment:
9 extruding lines
4 injection moulding machines
1 rotmoulding machines
 Raw material: **PE, PVC, PP**
 Annual production capacity:
10,000 T/year

6,800 sq.m outdoors storage area
6,000 sq.m covered storage area

Size range: **D 20 - D 630 mm**

Turnover 2025: **9,200,000 euro**
 Employees: **61**

Valrom Ukraine

Invisible innovation, visible impact.

12,800 sq.m
surface





ISO 9001

Guaranteed quality

International standard for quality management, ensuring reliable products that meet market requirements.



ISO 14001

Environmental protection

Efficient environment management system to reduce impact on the ecosystem.



ISO 45001

Occupational safety

Strict rules for safe and healthy workplaces through prevention and proactive improvement.



ISO 50001

Energy efficiency

Reduce energy consumption through sustainable solutions with minimal environmental impact.



Water



Gas



Sewerage



Heating



Filtration

Recognition

VALROM
is ranked at
GOLD LEVEL
According to Romania CST Index 2025
Based on a total score of 89 out of 100 points

Valid from March 2026
until February 2027

The Azores Sustainability and CSR Services & Allies for Sustainability

At Valrom Industrie, **social responsibility, environmental protection** and **sustainable development** are not just principles - they guide the way we operate every day. **Energy efficiency** is a key priority, and through continuous initiatives we reduce resource consumption and strengthen circular practices. We actively support the communities where we operate, contribute to local projects and invest in solutions that deliver real, measurable benefits.

Key performance indicators

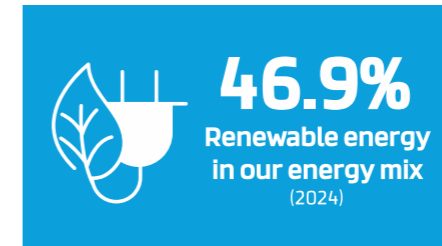
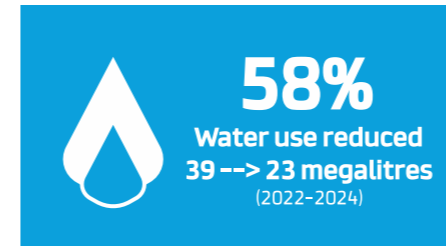

Recognition

In 2025, Valrom Industrie ranked among the **Top 15 Romanian companies** for transparency and performance in sustainable development. Our sustainability report was assessed by The Azores Sustainability & CSR Services and received **89/100 points**, achieving **Gold Level Recognition** within the **Romania CST Index 2025**, announced during the "Best Practices in Corporate Sustainability 2025" conference.

Sustainability

Invisible innovation, visible impact.





Quality guaranteed by standards and certifications
 Each Valrom system is designed according to the **highest quality standards**, complying with **international certifications** and rigorous **control processes**.

Laboratory ensuring **regular testing** of raw materials and manufactured products.

- MFR/MVR flow index test
- Analysis of material composition
- Continuous monitoring of wall thickness
- Surface and marking control
- Pressure resistance test
- Impact test
- Joint tightness tests
- Ring stiffness and flexibility tests
- Determining internal voltages



Laboratory

Invisible innovation, visible impact.



It's simple to enjoy complete systems



From design sizing to commissioning, we support our partners with **technical expertise and support** to deliver safe, efficient and compliant pipeline installations. We are at our partners' side at every project stage, combining intelligent pipe systems with practical know-how.

Technical services for B2B projects

- **System planning & concept support:** selection of installation method and pipe system, interfaces, accessories, and execution constraints
- **System dimensioning:** flow and pressure requirements, layout-related losses, operating conditions and applicable standards
- **Detailed design support:** validation of technical solutions, recommendations for configurations and components
- **Start-up & commissioning support:** on-site technical assistance when required, acceptance checks and troubleshooting
- **Technical guidance** for operation and maintenance: installation recommendations, maintenance support, replacement of components and accessories
- **Training & technical workshops:** product and system training, and best practices for distributors, installers, contractors and engineering teams

Deliverables (on request): sizing calculations, technical notes, recommended configurations, lists of materials, compliance documentation.

Technical department

Invisible innovation, visible impact.



It's easy when you're the partner of the leader

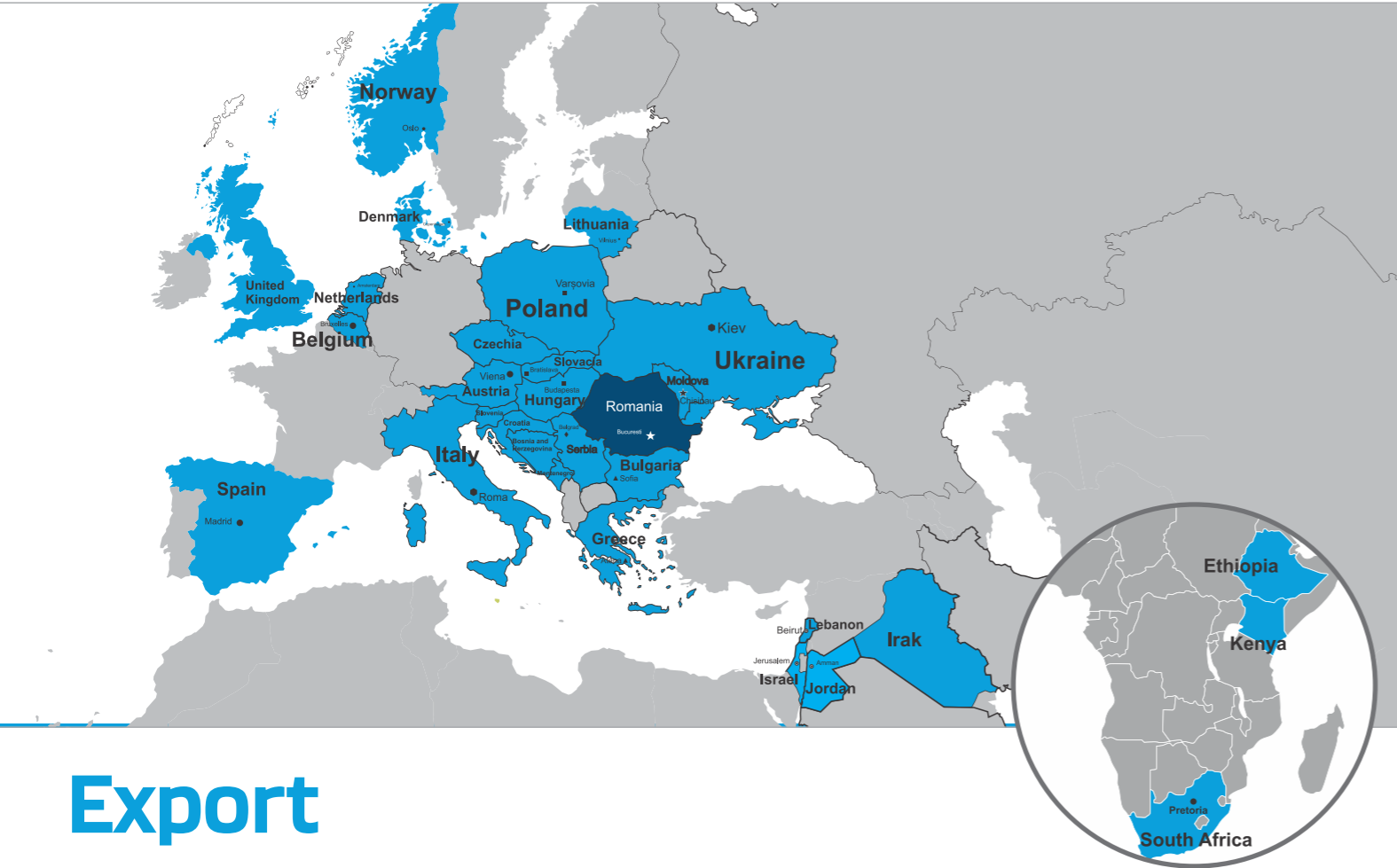

With a distribution network spanning **over 25 European countries** and beyond, Valrom Industrie builds **strong partnerships** with local distributors, contractors, and designers, actively contributing to sustainable regional development.

Valrom stands at the forefront of the industry, delivering **customized solutions** and **advanced technologies** tailored to meet the most demanding requirements.

Export

Invisible innovation, visible impact.

+25 countries



Water



Gas



Sewerage



Heating



Filtration

It's simple to enjoy complete systems



Valrom manufactures and supplies:

- **Water** and **gas** supply systems
- Internal and external **sewage** systems
- Domestic **wastewater treatment** systems
- **Sanitary** and **heating** systems
- **Filtration, water storage** and **pumping** systems

Ensuring quality, safety and efficiency.



Products

13,500 products supplied

6,000 products manufactured

Invisible innovation, visible impact.



It's simple to enjoy complete systems

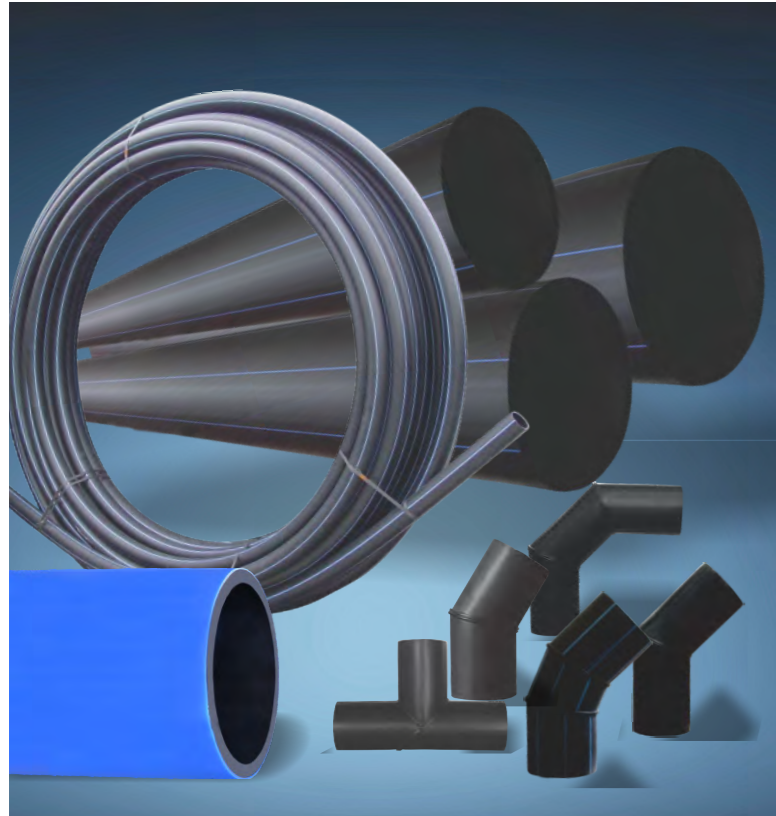

VALWater represents a complete system, designed for water distribution, irrigation and fire systems, consisting of HDPE pipes and fittings, water meter chambers.

Dimensions

HDPE pipes available diameters, between 20 and 1200 mm. Depending on diameter and SDR, pipes are delivered in coils (length 100 m or 200 m) or in bars (length 13 m).



VALGasio represents a complete system, designed for gas distribution.

Dimensions

HDPE pipes available diameters, between 32 and 800 mm. Pipes can be delivered in coils, having 100 or 200 m, for diameters up to 110 mm (included). Pipes can be delivered in 13 m bars, for upper diameters.

 **VALWater**

 **VALGasio**

Invisible innovation, visible impact.



It's simple to enjoy complete systems

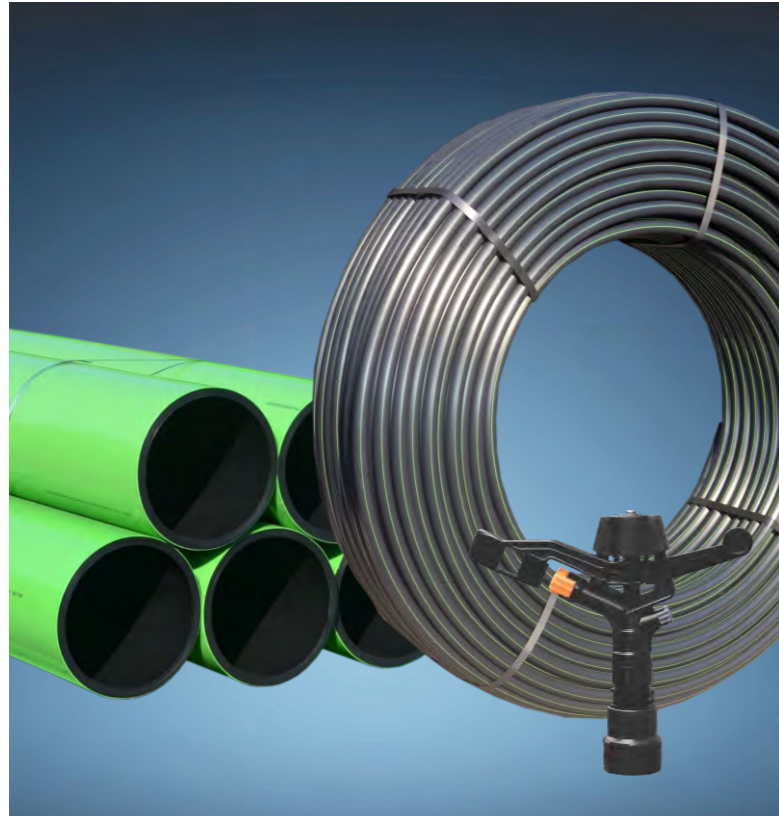

VALAgrio is a professional irrigation system consisting of pipes, fittings, valves and irrigation or sprinkler elements.



VALNetline is a complete system designed to install and protect cables and fiber optics used in communications networks. It consists of chambers, PEHD and PVC cable protection tubes, PEHD microtubes, connectors.

 **VALAgrio**

 **VALNetline**

Invisible innovation, visible impact.



Water



Gas



Sewerage



Heating



Filtration

It's simple to enjoy complete systems



VALCleanio represents a complete system, used for precleaning and cleaning waste waters.

- SBR waste water treatment plants for domestic applications
- septic tanks
- grease separators
- coalescing oil separators



VALPlast pipes and sewage collectors. Polyethylene sewage collectors represent the ideal solution for an efficient sewage applicability.

VALCleanio

VALPlast

Invisible innovation, visible impact.



Water



Gas



Sewerage



Heating



Filtration



VALSpring is designed for the construction of wells for groundwater extraction, intended for potable or industrial use. The system includes well casing pipes, filter pipes and accessories made entirely of unplasticised PVC (PVC-U). They meet the highest quality requirements of the field, while being economically efficient. Special properties of unplasticised PVC make it the ideal material for this kind of applications: absolutely corrosion resistant; easily formed as tubes [by extrusion] and easily machined; good mechanical strength; life over 50 years.



VALStock represents a complete system, used for liquid storage (water and/or other liquids for consumption). This tank can be also used as a buffer appliance.

VALSpring

VALStock



VALEasy is a system designed for waste water discharge inside buildings, consisting of polypropylene tubing and fittings. VALEasy PP pipes and fittings are used for:

- waste water discharge pipe (low and high temperature);
- rain water pipe;
- ventilation pipe.

The main advantages of the VALEasy system are as follows:

- high and low temperature resistance;
- extremely easy and fast installation;
- installation does not require the use of special tools;
- flexibility and highly resistant to scratching and abrasion.



VALFono is the soundproof system for wastewater consisting of push-fit pipes, fittings and accessories, with a wide range of diameters DN32 to DN160, for pipes, and from DN32 to DN110 for fittings. Pipes and fittings are made of mix of polypropylene with mineral fillers to ensure a good soundproofing performance.

It is certified SR EN 14366 according to the measurements made at Fraunhofer Institut für Bauphysik for the determination of acoustic performance.



VALDuotherm represents a complete system, used for interior cold/hot water supply systems, heating systems. Available diameters: between 20 and 110 mm.



VALThermio is a plastic piping system for hot and cold water installations and heating systems for houses, public and industrial buildings.

Application areas for VALThermio system:

- cold/hot water supply systems;
- radiating heating systems;
- floor or wall heating/cooling system and snow-melting.

 **VALDuotherm**

 **VALThermio**

Invisible innovation, visible impact.





VALHOH filtration systems are used in domestic applications with the ability to filter water mechanically, chemically and biologically, depending on the needs determined by specific analyzes.

The softening systems reduce water hardness eliminating the risk of limescale. Prevent the whitening of taps, sinks and sanitary items in contact with water and eliminate the risk of red and black stains on sanitary items. The drinking water is brought to the drinking parameters.



VALPurio is a point-of-entry potable water storage and pumping system for residential use. Depending on the variant chosen, it provides a water reserve of 500 or 700 liters. The storage and pumping (SP) tank uses the silver ion technology developed by Valrom in order to prevent the growth of microorganisms in the storage tank.



*Join us on this exciting journey
as we shape the future together!*

HEADQUARTER:

VALROM Industrie

28 Preciziei Blvd., 6 th District

062204, Bucharest, Romania

+40 21 317.38.00

office@valrom.ro

www.valrom.ro



Water



Gas



Sewerage



Heating



Filtration